

Seu Kit Fotovoltaico, Direto da Distribuidora



Veja nosso
catálogo
de **Produtos
Fotovoltaicos**



skysollaris.com.br



Entre em contato

49. **3442.0072**



sky
SOLLARIS

Olá integrador! O que acha de economizar na compra do seu Kit?

Com mais de 10 anos de experiência no setor solar, atuamos em todo o território nacional por meio de nossos parceiros e integradores, oferecendo soluções completas em fornecimento de materiais fotovoltaicos.

Atendemos projetos de diferentes portes, desde residenciais e comerciais até industriais e grandes usinas de investimento, sempre com foco em rentabilidade, qualidade e agilidade na entrega.



Painéis Solares

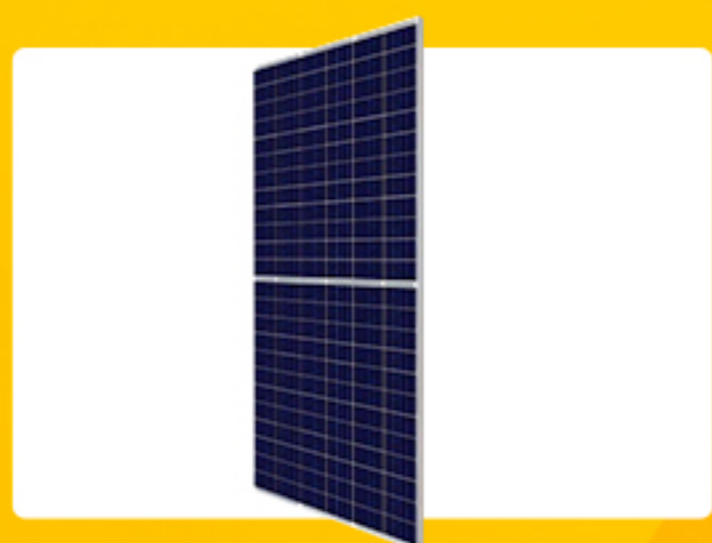

Cod.: 1620 ↗ TIER 1

450W CANADIAN
EFICIÊNCIA: 20,40%



Cod.: 1474 ↗ TIER 1

540W SERAPHIM
EFICIÊNCIA: 20,90%

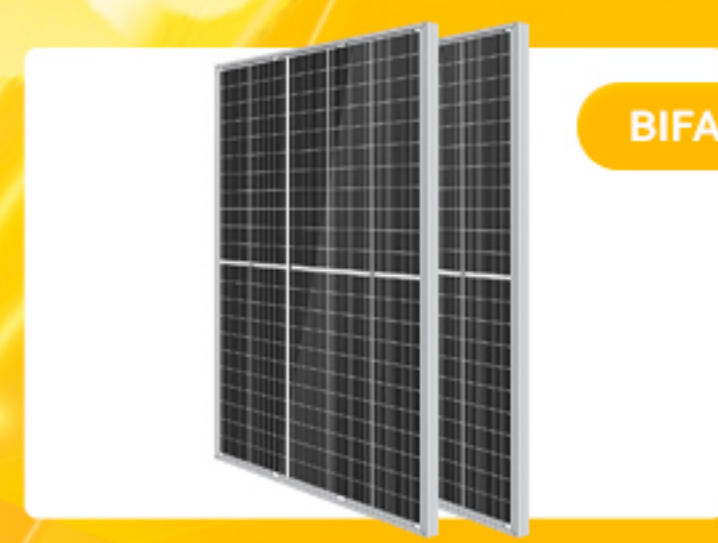

Cod.: 1582 ↗ TIER 1

550W SKY SOLLARIS
EFICIÊNCIA: 21,05%

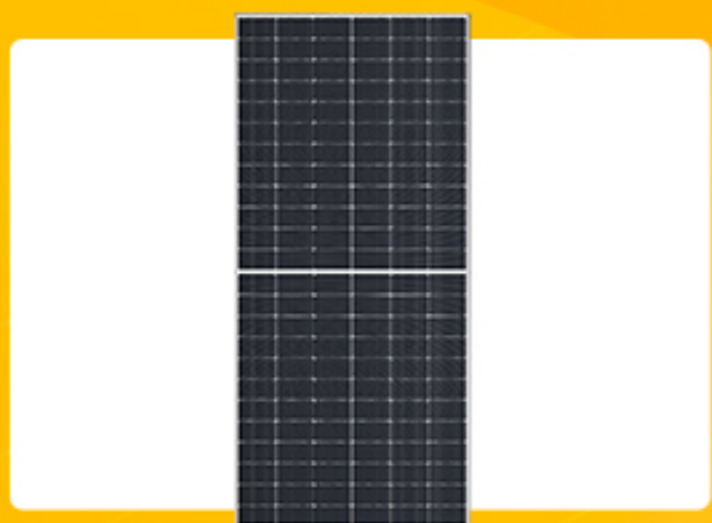

Cod.: 1993 ↗ TIER 1

555W HANERSUN
EFICIÊNCIA: 21,48%



Cod.: 2435 ↗ TIER 1

585W ERA SOLAR
EFICIÊNCIA: 22,65%



Cod.: 2537 ↗ TIER 1

585W RENESOLA
EFICIÊNCIA: 22,65%



Cod.: 2546 ↗ TIER 1

585W OSDA
EFICIÊNCIA: 22,60%



Cod.: 2464 ↗ TIER 1

610W ERA SOLAR
EFICIÊNCIA: 22,60%

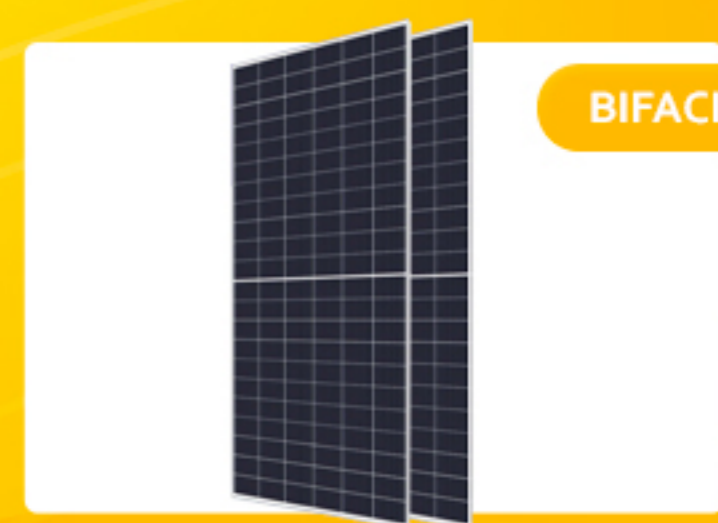

Cod.: 1033 ↗ TIER 1

660W RISEN
EFICIÊNCIA: 21,20%



Potência para todos os projetos, alta eficiência, durabilidade comprovada e tecnologia que garante mais energia todos os dias.



Painéis Solares



Cod.: 1956 ↗  TIER 1

670W LUXEN
EFICIÊNCIA: 21,60%

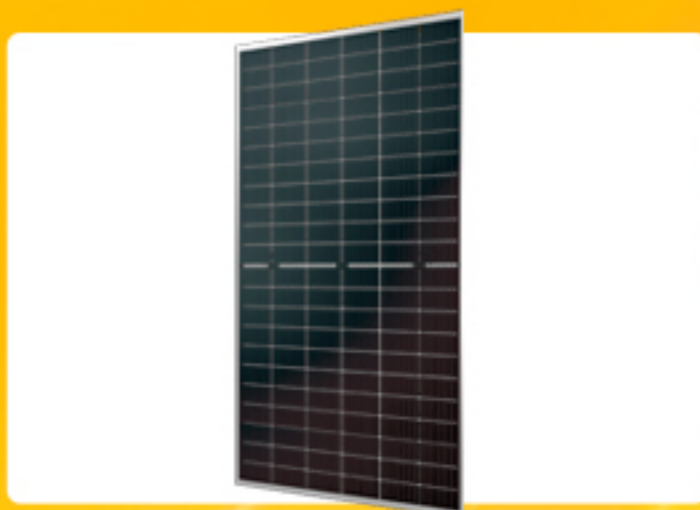

Cod.: 1166 ↗  TIER 1

700W ERA SOLAR
EFICIÊNCIA: 22,53%

Destaque para:

Era Solar 700W

Bifacial HJT
Half Cell



**Eficiência de 22,53%,
uma das mais altas
do mercado!**



Confira aqui a Linha Completa de
Painéis Solares

Inversores Solis



Cod.: 553 ↗

MINI-3000-4G - 1 MPPT/
1 ENTRADA - MONO 220V



Cod.: 1934 ↗

S6-GR1P4K - 2 MPPTS/
2 ENTRADAS - MONO 220V



Cod.: 2436 ↗

S6-GR1P5K-S - 2 MPPTS/
2 ENTRADAS - MONO 220V



Cod.: 2430 ↗

S6-GR1P6K-S - 2 MPPTS/
2 ENTRADAS - MONO 220V



Cod.: 1863 ↗

1P7.7K-5G - 2 MPPTS/
3 ENTRADAS - MONO 220V



Cod.: 2135 ↗

S5-GR1P8K - 3 MPPTS/
3 ENTRADAS - MONO 220V



Cod.: 1937 ↗

S5-GR1P9K - 3 MPPTS/
3 ENTRADAS - MONO 220V



Cod.: 2134 ↗

S5-GR1P10K - 3 MPPTS/
3 ENTRADAS - MONO 220V



Cod.: 1938 ↗

S5-GR3P12K - 2 MPPTS/
4 ENTRADAS - TRIF 380V



Controle inteligente de energia, máxima confiabilidade, segurança aprimorada e alta performance para extrair o melhor do seu sistema solar.



sky
SOLLARIS

Inversores Solis



Cod.: 2139 ↗

S5-GR3P15K - 2 MPPTS/
4 ENTRADAS - TRIF 380V



Cod.: 734 ↗

15K-LV - 2 MPPTS/
4 ENTRADAS - TRIF 220V



Cod.: 1940 ↗

S5-GR3P20K - 2 MPPTS/
4 ENTRADAS - TRIF 380V



Cod.: 1939 ↗

S5-GC20K-LV - 3 MPPTS/
6 ENTRADAS - TRIF 220V



Cod.: 2147 ↗

S5-GC25K - 3 MPPTS/
6 ENTRADAS - TRIF 380V



Cod.: 1699 ↗

25K-LV - 2 MPPTS/
6 ENTRADAS - TRIF 220V



Cod.: 1942 ↗

S5-GC30K - 3 MPPTS/
6 ENTRADAS - TRIF 380V



Cod.: 1943 ↗

S5-GC30K-LV - 4 MPPTS/
8 ENTRADAS - TRIF 220V



Cod.: 1835 ↗

S5-GC37.5K-LV - 4 MPPTS/
8 ENTRADAS - TRIF 220V



Mais capacidade de geração, gerenciamento otimizado e confiabilidade industrial para projetos que exigem alto desempenho solar.



sky
SOLLARIS

Inversores Solis



Cod.: 1944 ↗

S5-GC40K - 4 MPPTS/
8 ENTRADAS - TRIF 380V



Cod.: 1864 ↗

S5-GC50K - 5 MPPTS/
10 ENTRADAS - TRIF 380V



Cod.: 2162 ↗

50K-LV-5G - 6 MPPTS/
12 ENTRADAS - TRIF 220V



Cod.: 1865 ↗

S5-GC60K - 6 MPPTS/
12 ENTRADAS - TRIF 380V



Cod.: 2438 ↗

S6-GC60K-LV - 8 MPPTS/
16 ENTRADAS - TRIF 220V



Cod.: 2437 ↗

75K-5G-PRO - 6 MPPTS/
12 ENTRADAS - TRIF 380V



Cod.: 2439 ↗

S6-GC75K-LV - 8 MPPTS/
16 ENTRADAS - TRIF 220V



Cod.: 1073 ↗

100K-5G-PRO - 8 MPPTS/
16 ENTRADAS - TRIF 380V



Cod.: 1074 ↗

110K-5G-PRO - 8 MPPTS/
16 ENTRADAS - TRIF 380V



Máxima Otimização em Escala: Múltiplos MPPTS,
Varredura de Curva I-V e Geração Superior para
o Retorno do seu Investimento.



sky
SOLLARIS

Inversores Solis



Cod.: 1259 ↗



125K-EHV-5G - 1 MPPT/
20 ENTRADAS - TRIF 600V



Cod.: 1866 ↗



250K-EHV-5G+ - 12 MPPTS/
24 ENTRADAS - TRIF 800V



Cod.: 1867 ↗



255K-EHV-5G+ - 12 MPPTS/
24 ENTRADAS - TRIF 800V

Destaque para:



TECNOLOGIA AFCI

Inversor Solis S5-GRIP9K -
3 MPPTs/3 entradas -
mono 220V

Protege sua
instalação contra
arcos e incêndios
elétricos.

Garante mais
segurança e
prevenção
inteligente.



Confira aqui a Linha Completa de
Inversores Solis



sky
SOLLARIS

Inversores SAJ



Cod.: 1003 ↗

R5-3K-S1 - 1 MPPT/
1 ENTRADA - MONO 220V



Cod.: 1267 ↗

R5-17K-T2 - 2 MPPTS/
4 ENTRADAS - TRIF 380V



Cod.: 1006 ↗

R5-20K-T2 - 2 MPPTS/
4 ENTRADAS - TRIF 380V



Cod.: 1008 ↗

20K TRIF 220V 3 MPPTS/
6 ENTRADAS



Cod.: 2544 ↗

R6-30K-T3-32 - 3 MPPTS/
6 ENTRADAS - TRIF 380V



Cod.: 1008 ↗

33K TRIF 380V 3 MPPTS/
6 ENTRADAS



Cod.: 1011 ↗

35K TRIF 220V 3 MPPTS/
12 ENTRADAS



Cod.: 1011 ↗

60K TRIF 380V 3 MPPTS/
12 ENTRADAS



Cod.: 2545 ↗

C6-75K-T6-40 - 6 MPPTS/
12 ENTRADAS - TRIF 380V



Projetos Monofásicos e Trifásicos: Design Compacto, Operação Ultra Silenciosa e Eficiência Imbatível para sua Instalação Solar.



sky
SOLLARIS

Inversores Deye



Cod.: 1315 ↗

SUN-10K-G - 2 MPPTS/
4 ENTRADAS - MONO 220V



Cod.: 1270 ↗

SUN-15K-G03 - 2 MPPTS/
3 ENTRADAS - TRIF 380V



Cod.: 2149 ↗

SUN-20K-G04 - 2 MPPTS/
6 ENTRADAS - TRIF 380V



Cod.: 1273 ↗

SUN-25K-G - 2 MPPTS/
6 ENTRADAS - TRIF 380V



Cod.: 1275 ↗

SUN-33K-G - 2 MPPTS/
6 ENTRADAS - TRIF 380V



Cod.: 1946 ↗

SUN-33K-G03 - 3 MPPTS/
9 ENTRADAS - TRIF 380V



Cod.: 1141 ↗

SUN-35K-G - 3 MPPTS/
9 ENTRADAS - TRIF 380V



Cod.: 1947 ↗

SUN-35K-G03 - 3 MPPTS/
9 ENTRADAS - TRIF 380V



Cod.: 1976 ↗

SUN-40K-G03 - 3 MPPTS/
9 ENTRADAS - TRIF 380V



Inversores Mono e Trifásicos. Múltiplos MPPTS e entradas para máxima flexibilidade e otimização do seu projeto.



sky
SOLLARIS

Inversores Deye



Cod.: 1276 ↗

SUN-45K-G03 - 3 MPPTS/
9 ENTRADAS - TRIF 380V



Cod.: 1277 ↗

SUN-50K-G03 - 4 MPPTS/
12 ENTRADAS - TRIF 380V



Cod.: 1143 ↗

SUN-75K-G - 4 MPPTS/
16 ENTRADAS - TRIF 380V

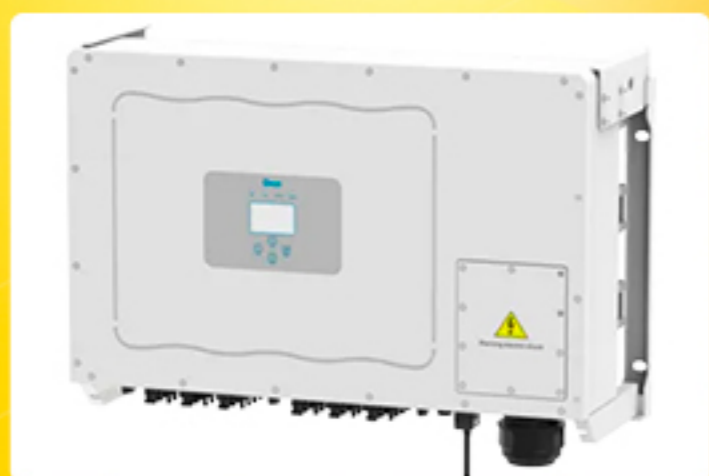

Cod.: 2184 ↗

SUN-100K-G03
TRIF 380V



Cod.: 1273 ↗

SUN-15K-G02 - 2 MPPTS/
6 ENTRADAS - TRIF 220V



Cod.: 2168 ↗

SUN-20K-G02
TRIF 220V



Cod.: 1946 ↗

SUN-20K-G02 - 3 MPPTS/
9 ENTRADAS - TRIF 220V



Cod.: 1276 ↗

SUN-25K-G02 - 3 MPPTS/
9 ENTRADAS - TRIF 220V



Cod.: 1277 ↗

SUN-30K-G02 - 4 MPPTS/
12 ENTRADAS - TRIF 220V



Inversores Trifásicos 380V. Alta potência, até 6 MPPTS e flexibilidade superior de strings para projetos grandes.



sky
SOLLARIS

Inversores Deye



Cod.: 1143 ↗



SUN-45K-G02 - 4 MPPTS/
16 ENTRADAS - TRIF 220V



Cod.: 1427 ↗



3.6KW HIBRIDO - 2 MPPTS/
2 ENTRADAS - MONO 220V



Confira aqui a Linha Completa de
Inversores Deye



Modelos Trifásicos 220V de alta corrente e Inversores Híbridos. Solução ideal para sistemas com armazenamento de bateria (mono).



sky
SOLLARIS

Inversores Austa



Cod.: 2440 ↗

AU5K1P - 2 MPPTS/
2 ENTRADAS - MONO 220V



Cod.: 2441 ↗

AU6K1P - 2 MPPTS/
2 ENTRADAS - MONO 220V



Cod.: 2442 ↗

AU8K1P - 2 MPPTS/
3 ENTRADAS - MONO 220V



Cod.: 2443 ↗

AU10K1P - 2 MPPTS/
3 ENTRADAS - MONO 220V



sky
SOLLARIS

Inversores Renac



Cod.: 1923 ↗ 

R3-30K-G5 - 3 MPPTS/
6 ENTRADAS - TRIF 380V



Cod.: 1924 ↗ 

R3-40K-G5 - 4 MPPTS/
8 ENTRADAS - TRIF 380V



Cod.: 1925 ↗ 

NAC50K - 4 MPPTS/
8 ENTRADAS - TRIF 380V



Cod.: 1926 ↗ 

NAC60K - 3 MPPTS/
12 ENTRADAS - TRIF 380V



Microinversores & Seus acessórios



Cod.: 1983 ↗  DEYE

MICROINVERSOR
SUN-2000 G03



Cod.: 210 ↗  APSYSTEM

MICROINVERSOR
YC1000-3-220V



Cod.: 665 ↗  APSYSTEM

MICROINVERSOR
YC 600 110V



Cod.: 1166 ↗  APSYSTEM

MICROINVERSOR
QS1A 1500W



Cod.: 214 ↗  AUSTA

MICROINVERSOR
AU-1P20002G



Cod.: 214 ↗  APSYSTEM

ECU-R SEM VISOR
PARA YC1000 - YC600 - QS1



Soluções em Microinversores (DEYE, APSYSTEM e AUSTA). Máxima segurança e rendimento por módulo, com todos os acessórios de conexão inclusos.



SOLLARIS

MONTE SEU KIT COM

Microinversor Austa 2000W

Monitoramento integrado
e comunicação via
linha de energia!



Microinversor Austa AU-1P20002G — Potência de 2000 W, 97,1% de eficiência e Wi-Fi integrado para monitoramento remoto. Com proteção IP66/IP67 e resistência a raios de até 6000 V, oferece desempenho, segurança e confiabilidade em energia solar.

Sring-Box

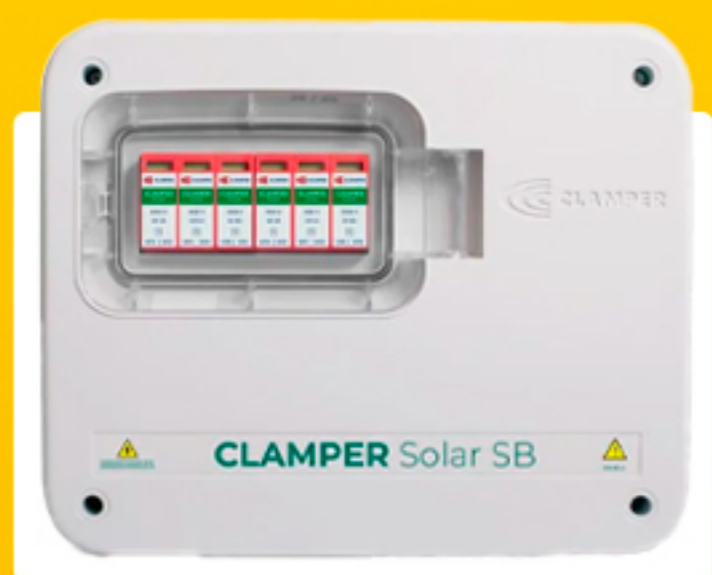

Cod.: 635 ↗

2 ENTRADAS
2 SAÍDAS 100V

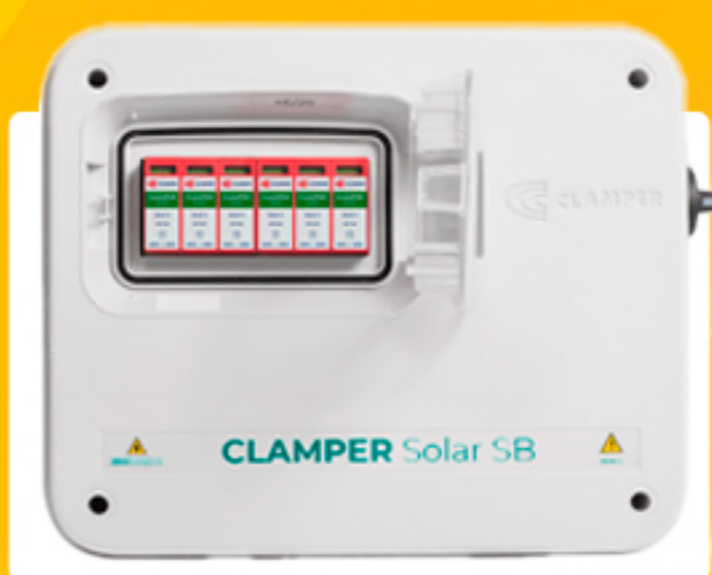

Cod.: 541 ↗

4 ENTRADAS
2 SAÍDAS 100V

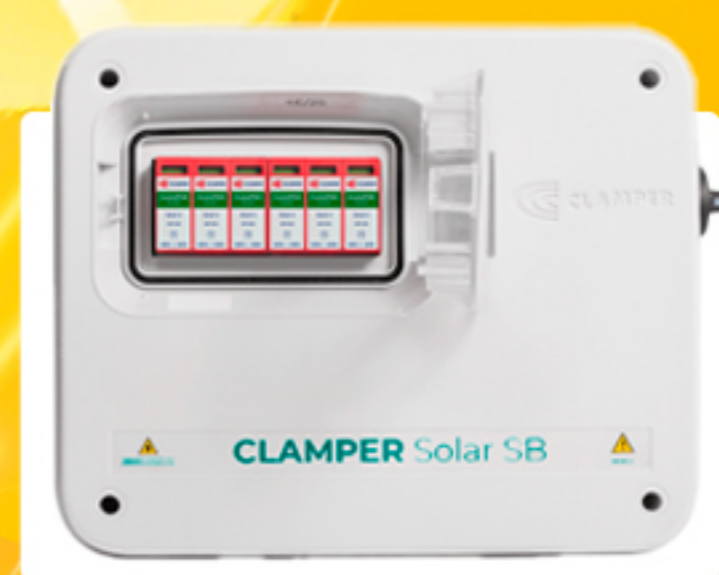

Cod.: 1410 ↗

4 ENTRADAS 2 SAÍDAS COM
DERIVAÇÃO PARA 4 SAÍDAS



sky
SOLLARIS

Cabos Solares



Cod.: 262 ↗

6MM² PRETO CABEL



Cod.: 263 ↗

6MM² VERMELHO CABEL



Cod.: 1576 ↗

6MM² VERDE CABEL



Cod.: 2128 ↗

4MM² PRETO CABEL



Cod.: 1041 ↗

4MM² VERMELHO CABEL



Cod.: 1040 ↗

EXTENSOR COM MC₄ PARA MÓDULOS 4MM² 1 METRO



Confira aqui a Linha Completa de Cabos Solares 4 e 6mm²



Linha completa de cabos (4mm² e 6mm²) nas cores padrão. Inclui extensores com conectores MC4 para instalação rápida e segura dos módulos.



sky
SOLLARIS

Conectores



Cod.: 2374 ↗

PAR DE CONECTOR
MC4 PROAUTO



Cod.: 1653 ↗

PAR DE CONECTOR
MC4 Y



Cod.: 1713 ↗

PAR DE CONECTOR
MC4 W



Cod.: 1135 ↗

END CAP PARA
MICROINVERSOR DEYE



Confira aqui a Linha Completa de
Conectores Solares



Potência elevada para projetos
solares, desempenho confiável e
proteção robusta IP65.



sky
SOLLARIS

Estruturas Solares



Cod.: 1686 ↗



MID CLAMP



Cod.: 1685 ↗



END CLAMP

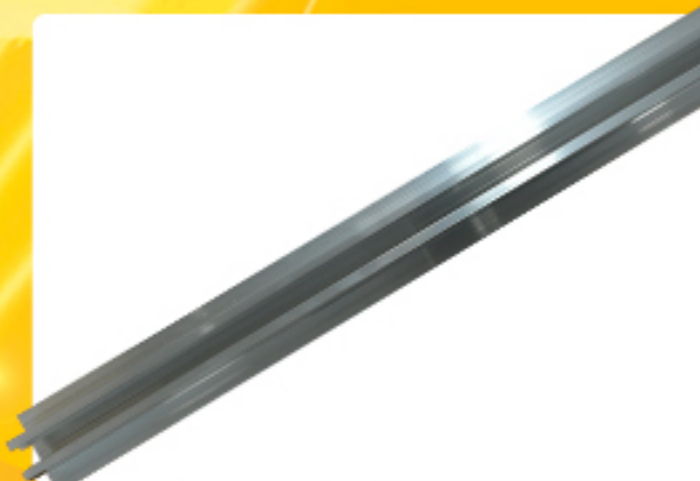

Cod.: 1694 ↗



MINITRILHO
55 CM



Cod.: 1898 ↗



MINITRILHO
30 CM

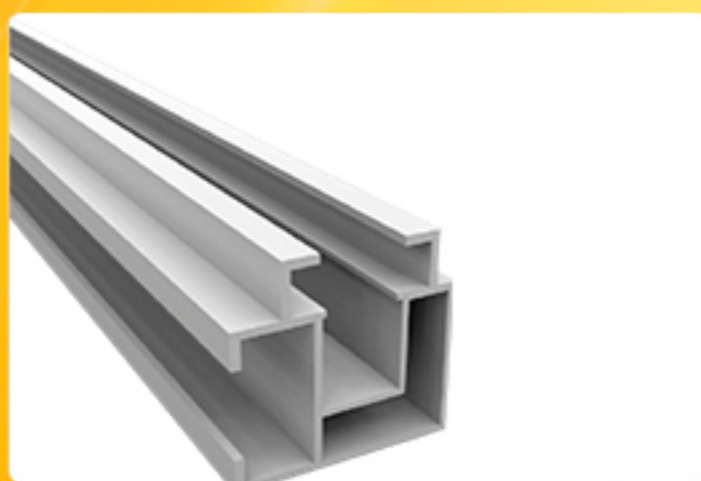

Cod.: 1731 ↗



TRILHO 2,4 M

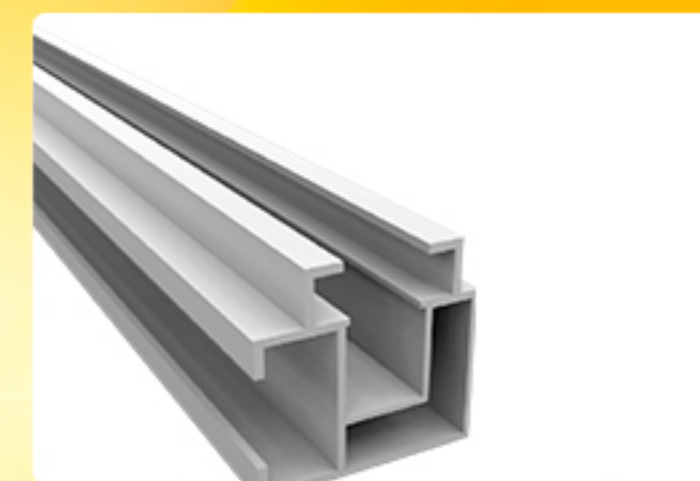

Cod.: 1901 ↗



TRILHO 3,6 M

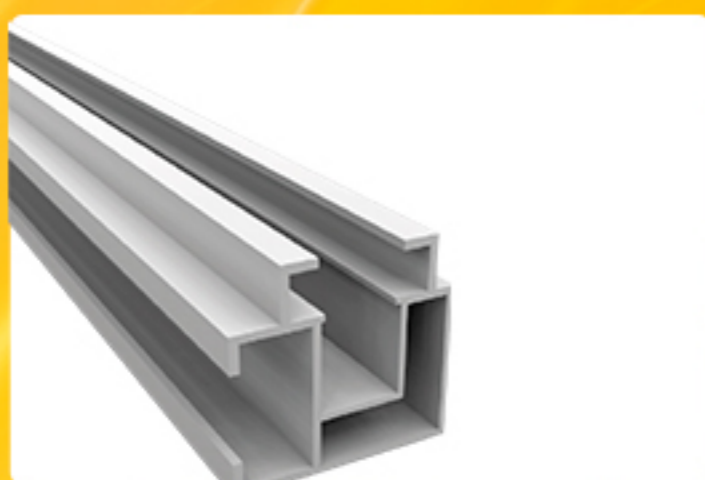

Cod.: 1687 ↗



TRILHO 4,8 M

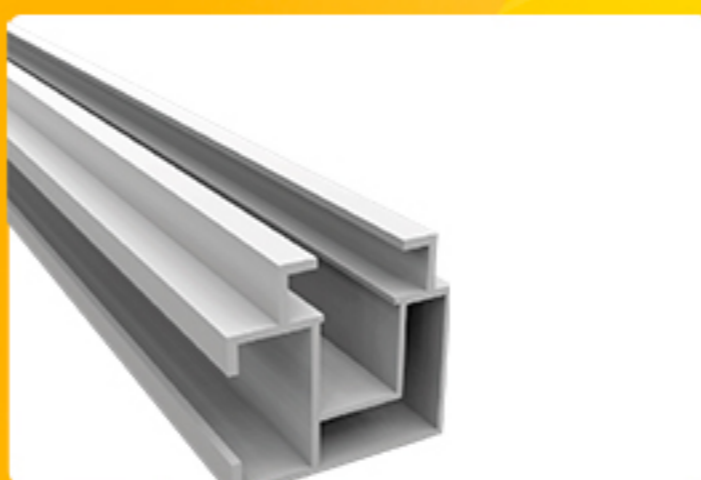

Cod.: 1903 ↗



TRILHO 2,7 M

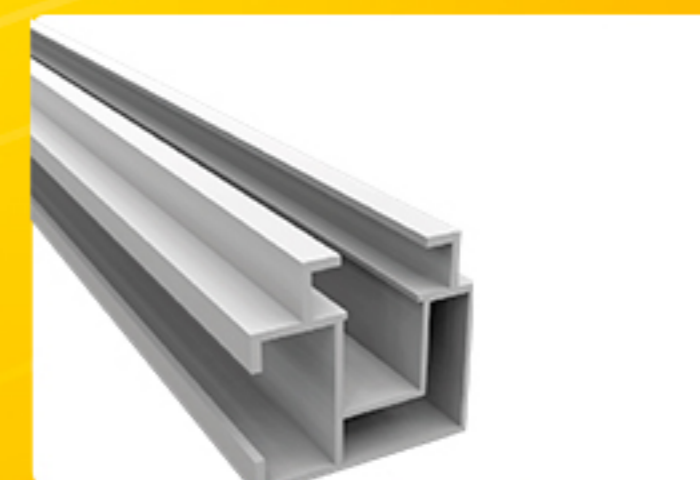

Cod.: 1687 ↗



TRILHO 4,1 M



Componentes essenciais para a fixação solar.
Trilhos e Mini-Trilhos de diversos tamanhos e clamps
(Mid/End) para instalação segura e profissional.



sky
SOLLARIS

Estruturas Solares



Cod.: 1574 ↗



EMENDA



Cod.: 1921 ↗



INOX

SUP. TELHA FIBROCIMENTO/
FIBROMADEIRA (10x200mm)



Cod.: 545 ↗



INOX

SUP. TELHA FIBROCIMENTO/
FIBROMADEIRA (10x250mm)



Cod.: 544 ↗



INOX

SUP. TELHA FIBROCIMENTO/
FIBROMADEIRA (10x300mm)



Cod.: 1530 ↗



INOX

SUPORTE TELHA
FIBROMETALICA



Cod.: 1730 ↗



SUPORTE TELHA
CERÂMICA



Cod.: 492 ↗



SUPORTE TELHA
ALUZINCO L



Cod.: 814 ↗



PARAFUSO SEXTAVADO
1/4x50 SUPORTE CERÂMICO



Cod.: 2052 ↗



PARAFUSO SEXTAVADO
5/16x50 P/ MICRO DEYE



Ampla variedade de suportes (Galvanizado/Inox) para diversos tipos de telhas (Fibrocimento, Cerâmica, Fibrometalica). Inclui emendas e parafusos para fixação completa e segura.



sky
SOLLARIS

Inversores SAJ SUNTRIO PLUS



Cod.: 1030 ↗ **GALVANIZADO**
ESTRUTURA RETRATO
SOLO FILEIRA SIMPLES
(MULTIPLO DE 4)



Cod.: 1031 ↗ **GALVANIZADO**
ESTRUTURA RETRATO
SOLO FILEIRA DUPLA
(MULTIPLO DE 8)



Cod.: 2163 ↗ **GALVANIZADO**
ESTRUTURA RETRATO
SOLO FILEIRA DUPLA
(MULTIPLO DE 12)



Cod.: 1446 ↗ **GALVANIZADO**
ESTRUTURA RETRATO
SOLO POLÍMERO



Cod.: 1774 ↗ **GALVANIZADO**
ESTRUTURA RETRATO
LAJE

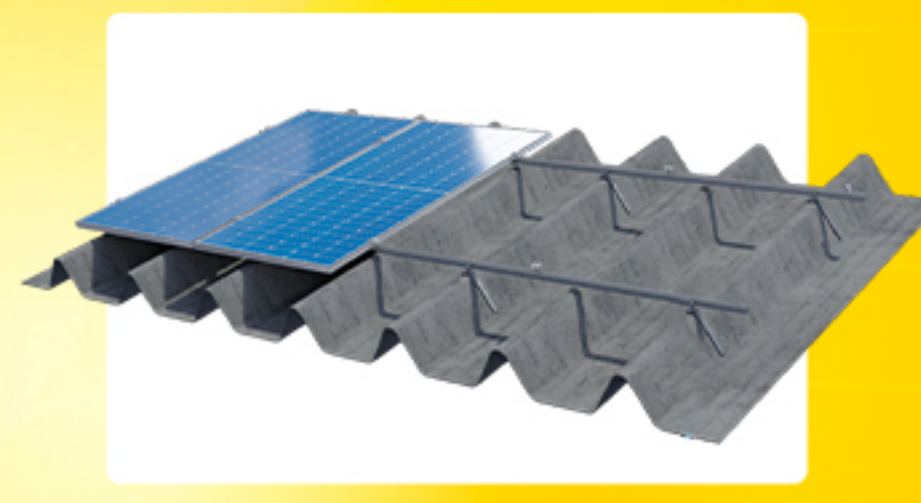

Cod.: 1641 ↗ **GALVANIZADO**
ESTRUTURA RETRATO
KALHETÃO

Estrutura Retrato Solo Fileira Simples e Dupla



Confira aqui a Linha Completa de
Estruturas Solares



sky
SOLLARIS

Autotransformador Trifásico

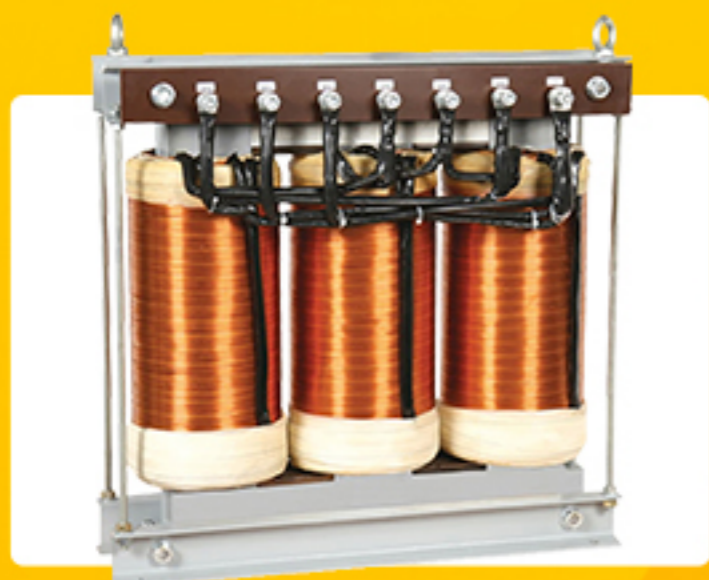

Cod.: 1297 ↗



20KVA EA 60HZ
E/S 220-380V



Cod.: 1298 ↗



25KVA EA 60HZ
E/S 220-380V



Cod.: 1840 ↗



30KVA EA 60HZ
E/S 220-380V



Cod.: 1312 ↗



35KVA EA 60HZ
E/S 220-380V



Cod.: 1299 ↗



INOX

40KVA EA 60HZ
E/S 220-380V



Cod.: 1314 ↗



45KVA EA 60HZ
E/S 220-380V



Cod.: 1300 ↗



50KVA EA 60HZ
E/S 220-380V



Cod.: 1313 ↗



60KVA EA 60HZ
E/S 220-380V - PT

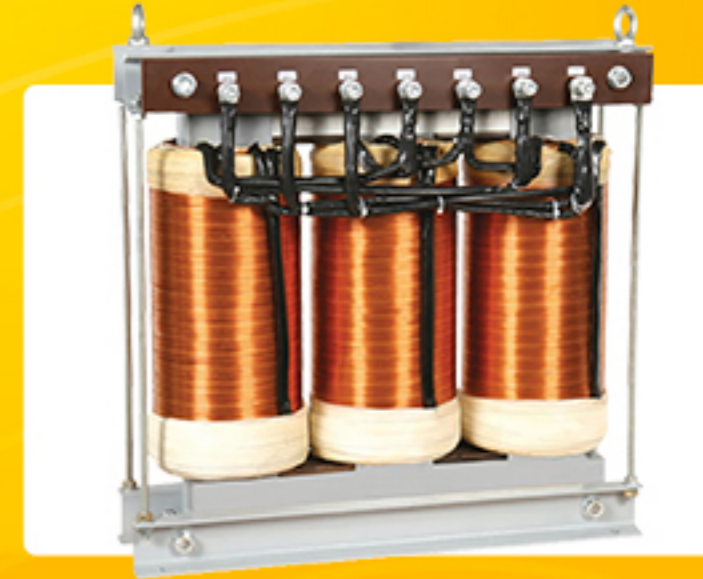

Cod.: 1841 ↗



70KVA EA 60HZ
E/S 220-380V - C27



Autotransformadores Trifásicos abertos (20kVA a 70kVA). Solução robusta e com alta potência para adequação de tensão 220V para 380V



sky
SOLLARIS

Autotransformador Trifásico



Cod.: 1302 ↗

75KVA EA 60HZ
E/S 220-380V - C27



Cod.: 1842 ↗

80KVA EA 60HZ
E/S 220-380V - C27



Cod.: 1843 ↗

85KVA EA 60HZ
E/S 220-380V - C27



Cod.: 1303 ↗

90KVA EA 60HZ
E/S 220-380V - C27



Cod.: 1304 ↗ INOX

100KVA EA 60HZ
E/S 220-380V - C27



Cod.: 1305 ↗

112,5KVA EA 60HZ
E/S 220-380V - C27



Cod.: 1306 ↗

125KVA EA 60HZ
E/S 220-380V - C27

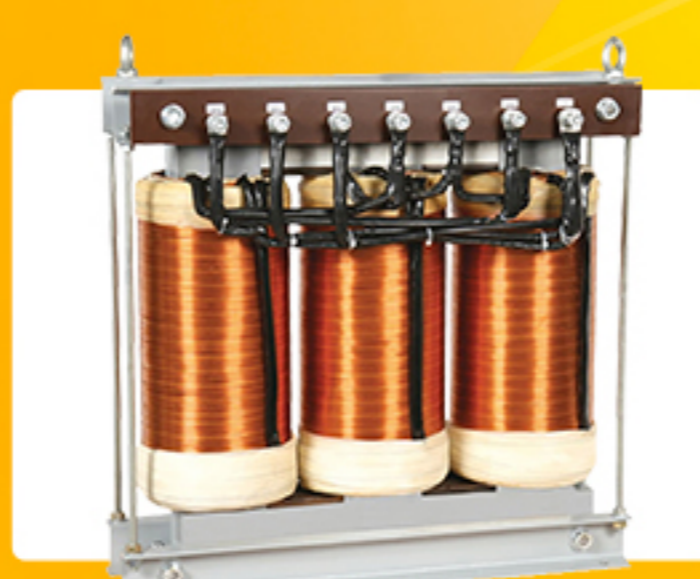

Cod.: 1308 ↗

150KVA EA 60HZ
E/S 220-380V -

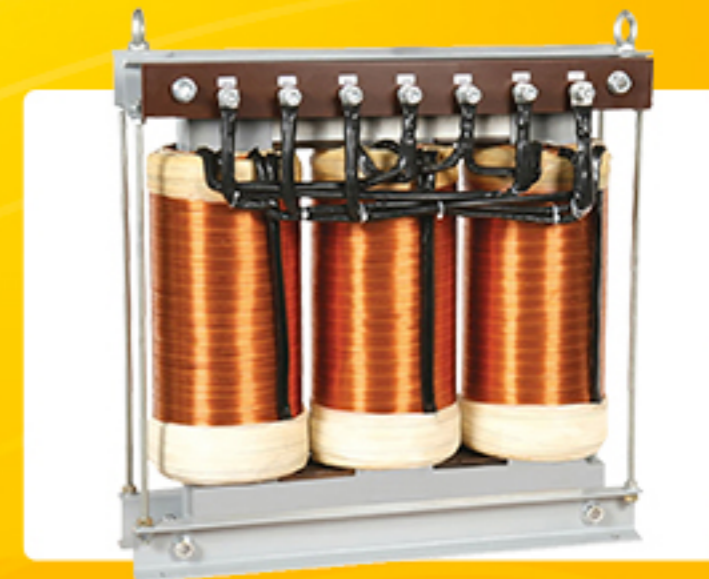

Cod.: 1309 ↗

200KVA EA 60HZ
E/S 220-380V - C27



Modelos de altíssima potência (até 200kVA) para grandes demandas de adequação de tensão em projetos industriais.



sky
SOLLARIS

Autotransformador Trifásico



Cod.: 1844 ↗



225KVA EA 60HZ
E/S 220-380V - C27



Cod.: 1310 ↗



250KVA EA 60HZ
E/S 220-380V - C27



Busque por quem
é especialista em
Energia Solar
Fotovoltaica



Modelos de altíssima potência (até 250kVA)
para grandes demandas de adequação de
tensão em projetos industriais.



sky
SOLLARIS

Com você Onde quer que esteja!



Entrega rápida e segura.
Em todo o Brasil!



Logística inteligente, mais
eficiência e **rastreamento**
em tempo real.

Estamos perto de você!

4 ESTADOS COM SEDE

+143 CIDADES ATENDIDAS

- Matriz - Concórdia-SC
- Filial - Curitiba-PR
- Filial - Cabedelo-PB
- Escritório - Campinas-SP



Smart LOGISTICS
+mais
flexibilidade na
SUA ENTREGA!



Alguns projetos
de nossos
Integradores
Parceiros



RIO DE JANEIRO ↗

5MW



BAHIA ↗

15MW



PIAUI ↗

30MW



BAHIA ↗

30MW



RIO DE JANEIRO ↗

750KW



MINAS GERAIS ↗

5MW



CEARÁ ↗

30MW



RIO DE JANEIRO ↗

1,5MW



CEARÁ ↗

30MW



ESPÍRITO SANTO ↗

2MW



skysollaris.com.br



Entre em contato
49.3442.0072



Olá
integrador!
O que acha
de **economizar**
na compra
do seu Kit?



A parceria que
impulsiona seu negócio **100%**